

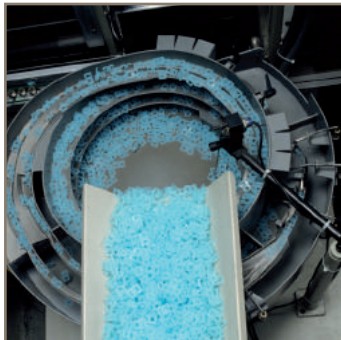

aerospace
climate control
electromechanical
filtration
fluid & gas handling
hydraulics
pneumatics
process control
sealing & shielding



DC590+ Series

DC Drives - Integrator Series



ENGINEERING YOUR SUCCESS.



WARNING – USER RESPONSIBILITY

FAILURE OR IMPROPER SELECTION OR IMPROPER USE OF THE PRODUCTS DESCRIBED HEREIN OR RELATED ITEMS CAN CAUSE DEATH, PERSONAL INJURY AND PROPERTY DAMAGE.

- This document and other information from Parker-Hannifin Corporation, its subsidiaries and authorized distributors provide product or system options for further investigation by users having technical expertise.
- The user, through its own analysis and testing, is solely responsible for making the final selection of the system and components and assuring that all performance, endurance, maintenance, safety and warning requirements of the application are met. The user must analyze all aspects of the application, follow applicable industry standards, and follow the information concerning the product in the current product catalog and in any other materials provided from Parker or its subsidiaries or authorized distributors.
- To the extent that Parker or its subsidiaries or authorized distributors provide component or system options based upon data or specifications provided by the user, the user is responsible for determining that such data and specifications are suitable and sufficient for all applications and reasonably foreseeable uses of the components or systems.

DC Drives - Integrator Series - DC590+ Series 1 A...1950 A

Overview	4
Technical characteristics	7
Technical Data.....	8
Dimensions	9
Frames	10
External Stack Controller - DC598+, DC599+ Series	14
Accessories and Options	15
Overview	15
Communication Cards	16
Encoder feedback card	17
Operator Keypads	18
Drive System Explorer Lite (DSE Lite) Software	19
Order Codes	20
DC590+ Integrator Series 2, 110 V...500 V 3 phase.....	20
DC590+ Integrator Series 2, 500 V...690 V 3 phase.....	21
DC590PX+ Integrator Series.....	22
DC590+ Series 2 External Stack Controllers.....	23

Parker Hannifin

The global leader in motion and control technologies

A world class player on a local stage

Global Product Design

Parker Hannifin has more than 40 years experience in the design and manufacturing of drives, controls, motors and mechanical products. With dedicated global product development teams, Parker draws on industry-leading technological leadership and experience from engineering teams in Europe, North America and Asia.

Local Application Expertise

Parker has local engineering resources committed to adapting and applying our current products and technologies to best fit our customers' needs.

Manufacturing to Meet Our Customers' Needs

Parker is committed to meeting the increasing service demands that our customers require to succeed in the global industrial market. Parker's manufacturing teams seek continuous improvement through the implementation of lean manufacturing methods throughout the process. We measure ourselves on meeting our customers' expectations of quality and delivery, not just our own. In order to meet these expectations, Parker operates and continues to invest in our manufacturing facilities in Europe, North America and Asia.

Electromechanical Worldwide Manufacturing Locations

Europe

Littlehampton, United Kingdom
Dijon, France
Offenburg, Germany
Filderstadt, Germany
Milan, Italy

Asia

Wuxi, China
Chennai, India

North America

Rohnert Park, California
Irwin, Pennsylvania
Charlotte, North Carolina
New Ulm, Minnesota



Offenburg, Germany

Local Manufacturing and Support in Europe

Parker provides sales assistance and local technical support through a network of dedicated sales teams and authorized technical distributors throughout Europe.

For contact information, please refer to the Sales Offices on the back cover of this document or visit www.parker.com



Milan, Italy



Littlehampton, UK



Filderstadt, Germany



Dijon, France

Variable Speed DC Drives - DC590+ Integrator Series 15 A - 1950 A

Overview

Description

The DC590+ Integrator Series DC drive is the latest development of the range which also includes the AC690+ AC drives. It benefits from 30 years experience of designing and manufacturing drives for process line control with dedicated function blocks which simplify the implementation of applications such as sectional drive reels, winder control etc. The function block capabilities offer unparalleled flexibility in both new installations and retrofit applications. A number of common fieldbus communications options enable connectivity to a wide range of popular control networks allowing the DC590+ to be integrated in larger control systems.

Features

- **Ratings up to 1950 A and supply voltages to 690 V**
- **Internal controlled field supply**
Function blocks programming, including open and closed-loop winder control as standard

Standards

The DC590+ series meets the following standards when installed in accordance with the relevant product manual.

CE marked to EN50178 (Safety, Low Voltage Directive)
EN61800-3 (EMC Directive) with integral filters.
External supply capacitors are required up to 110 A for compliance.

- **Supply Voltage 220...500 V as standard**
- **CE marked**
- **UL an cUL approved up to 830 A**

For customers wanting to upgrade from the earlier DC590C analog DC drive, wishing to benefit from the extra functionality and capability of the DC590P, a DC590PX variant is available which enables the new DC590P control section to be used with an existing DC590C power stack. This has the same form factor and terminal arrangements as the earlier DC590C product.



Technical Characteristics - Overview

Power configuration	DC590+ 4 quadrant regenerative; 2 fully controlled 3 phase thyristor bridges DC591+ 2 quadrant; 1 fully controlled 3 phase thyristor bridge
Armature rating (ADC)	Frame 1 15, 35 A Frame 2 40, 70, 110, 165 A Frame 3 180, 270 A Frame 4 380, 500, 725, 830 A Frame 6 1250, 1600, 1950 A
Overload	15...450 A; 200 % for 10 s 150 % for 30 s - from 700 A: several overload choices are available
Supply voltage (VAC) 50/60 Hz	220...500 V ($\pm 10\%$) Frame 1...4 110...220 V ($\pm 10\%$) Option Frame 1...4 500...600 V ($\pm 10\%$) Option Frame 4 380...600 V ($\pm 10\%$) Frame 6 380...690 V ($\pm 10\%$) Frame 6
Field current max	4 A Frame 1 10 A Frame 2 and 3 30 A Frame 4
Field voltage max	$V_{field} = VAC \times 0.82$
Operating Environment	
Operating temperature	0...45 °C (15...165 A) 0...35 °C (180...270 A) 0...40 °C (current ≥ 1200 A) derate by 1 %/°C up to 55 °C max
Altitude	500 m above sea level Derate by 1 %/200 m above 500 m to 5000 m max

Next Generation Technology

Building upon the highly successful DC590+ drive used in thousands of applications world-wide, the DC590+ Integrator drive takes DC motor control to the next level. With its state-of-the-art advanced 32-bit control architecture, the DC590+ drive delivers highly functional and flexible control suited to a whole host of industrial applications.

Typical Applications

- **Converting machinery**
- **Plastics and rubber processing machinery**
- **Wire and cable**
- **Material handling systems**
- **Automotive**

Function Block Programming

Function Block Programming is a tremendously flexible control structure that allows an almost infinite combination of user functions to be realised with ease. Each control function (an input, output, process PID for example) is represented as a software block that can be freely interconnected to all other blocks to provide any desired action.

The drive is despatched with the function blocks pre-configured as a standard DC drive so you can operate it straight from the box without further adjustments. Alternatively you can pick pre-defined Macros or even create your own control strategy, often alleviating the need for an external PLC and therefore reducing cost. Feedback Options

The DC590+ has a range of interface options which are compatible with the most common feedback devices enabling simple motor control through to the most sophisticated multi-motor system. Armature voltage feedback is standard without the need for any interface option.

- **Analogue tachogenerator**
- **Encoder**

Interface Options

Designed with connectivity in mind, the DC590+ has a number of communications and I/O options that allow the drive to take control of the application, or be integrated into a larger system. When combined with function programming, custom functions and control can be easily created offering the user a highly flexible and versatile platform for DC motor control.

Programming/ Operator Controls

Featuring an intuitive menu structure, the ergonomically designed operator panel allows quick and easy access to all parameters and functions of the drive via a bright, easy to read backlit display and tactile keypad. Additionally, it provides local control of start/stop, speed demand and rotation direction to greatly assist with machine commissioning.

- **Multi-Lingual alpha-numeric display**
- **Customised parameter values and legends**
- **On drive or remote mounting**
- **Local control of start/stop, speed and direction**
- **Quick set-up menu**

Connectivity

Whatever the complexity of your control scheme, the DC590+ has the interface to suit. As standard there's enough analogue and digital I/O for the most complex applications. Alternatively, add the relevant "technology box" for immediate access to serial communications and Fieldbus networks. The DC590+ has been designed to fit seamlessly, and without compromise, into any control environment.

Analogue/Digital Control

- 5 Analogue Inputs (12bit + sign)
- 3 Analogue Outputs
- 9 Digital Inputs
- 3 Digital Outputs

Serial Communications and Fieldbus Options

- PROFIBUS
- CANopen
- Devicenet
- RS485 / Modbus
- ControlNet
- EtherNet



6901 Programming/ Operator Controls

Features and Benefits

Easy to use operator controls

- Detailed diagnostics
- Multi-language display

Advanced autotuning

Standard open fieldbuses



Configurable input-output terminal blocks

- 5 analogue inputs
- 3 analogue outputs
- 9 digital inputs
- 3 digital outputs

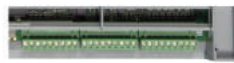

Macro function blocks

- Open-loop winder control
- Winder control - loadcell/dancer
- Section control
- Maths functions
- Embedded controller functions

Worldwide product support

The DC590+ DC Drive is available with full application and service support in over fifty countries worldwide. So wherever you are, you can be confident of full back up and support.



Rapid Commissioning, optimal control performance and easy maintenance

With its self-tuning algorithm, the DC590+ can be configured and commissioned within minutes, without turning the motor and without the need for high levels of engineering know-how. The operator interface allows easy monitoring of machine operation and simplifies maintenance.

Easy integration into existing control networks

The DC590+ has a wide choice of common industry fieldbus communication options allowing seamless integration into existing factory control networks.

Interfacing with existing external control equipment (Dancer, gauge, etc...)

A number of input / output options gives the DC590+ the flexibility needed for integration into any variable speed system. Combined with its embedded automation functions, its input-output configurations can in many instances remove the need for an external PLC.

Years of applications expertise at your service

The DC590+ macro function blocks are the result of over 30 years of experience gained by Parker SSD of installing drives in variable speed and sectional drive systems. This unique application experience is included in the drive in the form of dedicated function blocks at no extra cost, thereby reducing the design costs of your machinery.

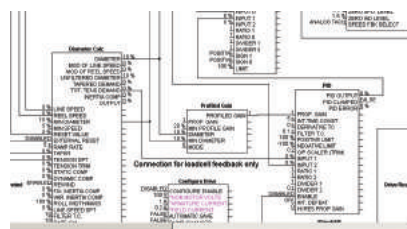

Technical characteristics

Electrical characteristics

Voltage	Output current [A]		Field current max [A]	Frame	Order code ¹
	Continuous 100 %	Overload			
	without overload	150 % x 30 s 200 % x 10 s			
110 V - 220 V	15	15	4	1	590P-2321501...
	35	35	4	1	590P-2323501...
	40	40	1	2	590P-2324002...
	70	70	10	2	590P-2327002...
	110	110	10	2	590P-2331102...
	165	165	10	2	590P-2331652...
	180	180	10	3	590P-2331803...
	270	270	10	3	590P-2332703...
	420	380	30	4	590P-2333804...
	550	500	30	4	590P-2335004...
220 V - 500 V	800	725	30	4	590P-2337254...
	910	830	30	4	590P-2338304...
	15	15	4	1	590P-5321501...
	35	35	4	1	590P-5323501...
	40	40	10	2	590P-5324002...
	70	70	10	2	590P-5327002...
	110	110	10	2	590P-5331102...
	165	165	10	2	590P-5331652...
	180	180	10	3	590P-5331803...
	270	270	10	3	590P-5332703...
	420	380	30	4	590P-5333804...
	550	500	30	4	590P-5335004...
	800	725	30	4	590P-5337254...
	910	830	30	4	590P-5338304...
500 V - 600 V	1350	1250	60	6	590P-5341256...
	1750	1600	60	6	590P-5341606...
	2150	1950	60	6	590P-5341956...
	420	380	30	4	590P-6333804...
500 V - 690 V	550	500	30	4	590P-6335004...
	800	725	30	4	590P-6337254...
	910	830	30	4	590P-6338304...
	1350	1250	60	6	590P-7341256...
500 V - 690 V	1750	1600	60	6	590P-7341606...
	1950	1850	60	6	590P-7341956...

⁽¹⁾ The references are for 4Q drives
 For 2Q drives, replace "590P" for "591P"

Technical Data

Protection	High energy MOV's Heatsink overtemperature Instantaneous overcurrent Thyristor trigger failure Inverse time overcurrent Interline snubber network Field Failure Zero speed detection Speed feedback failure Stall protection Motor overtemperature
Inputs/Outputs	
Analogue inputs	(5 Total - 1 x 12 bit plus sign, 4 x 10 bit plus sign) 1 - Speed demand setpoint (-10/0/+10 V) 4 - Configurable
Analogue outputs	(3 Total - 10 bit) 1 - Armature current output (-10/0/+10 V or 0-10 V) 2 - Configurable
Digital inputs	(9 Total - 24 V, max 15 mA) 1 - Program stop 1 - Coast stop 1 - External stop 1 - Start/Run 5 - Configurable
Digital outputs	(3 Total - 24 V (max 30 V) 100 mA) 3 - Configurable
Reference supplies	1 - +10 VDC 1 - -10 VDC 1 - +24 VDC

Dimensions

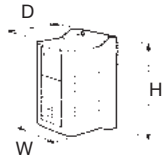

Frame 1/2

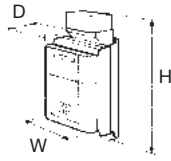

Frame 3

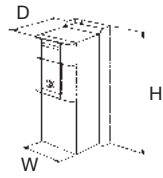

Frame 4

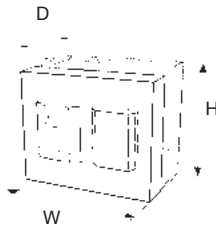

Frame 6

Current [A]	Frame	Dimensions [mm]			Weight [kg]
		W	H	D	
15/35	1	200	375	220	6.4
40/165	2	200	434	292	10.5
180/270	3	250	485	234	20
380/500	4	253	700	358	32
725/830					44
1250/1950	6 2Q	686	715	378	95
	6 4Q				110

Overview of Frames

Frames 1 and 2

1	Main drive assembly
2	Terminal cover
3	Terminal cover retaining screws
4	Blank cover
5	6901 keypad (optional)
6	COMMS technology box (optional)
7	Speed feedback technology card (optional)
8	Gland plate
9	Power terminal shield
10	Power terminals
11	Control terminals
12	Earthing points
13	Keypad port
14	RS232 programming port
15	Auxiliary power, external contactor and isolated thermistor terminals

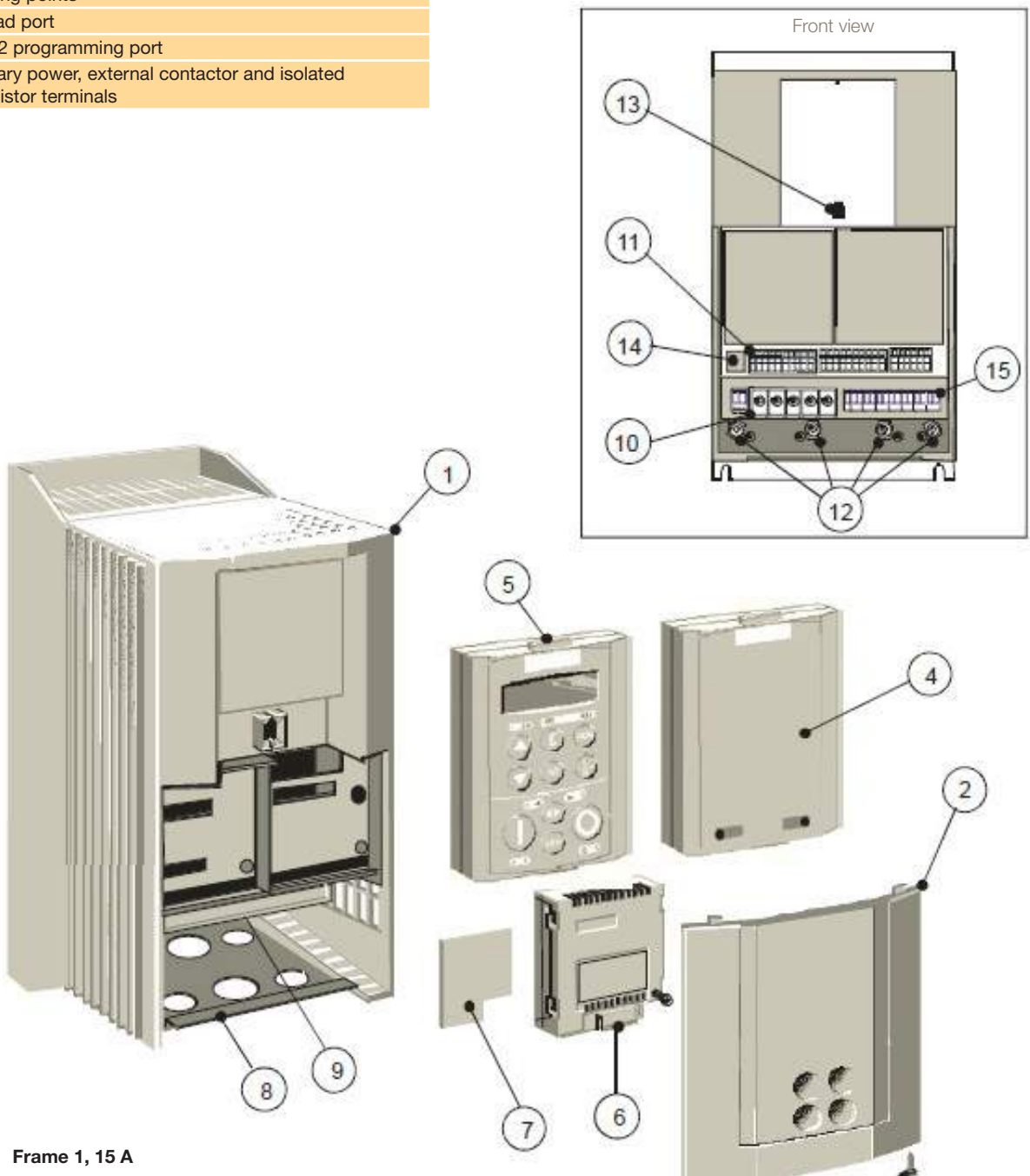

Frame 1, 15 A

Overview of Frame 3

1	Main drive assembly
2	Door assembly
3	Field wiring terminals
4	Busbars - main power input
5	Busbars - main power output
6	IP20 Top cover)
7	IP20 Fan housing (where fitted)

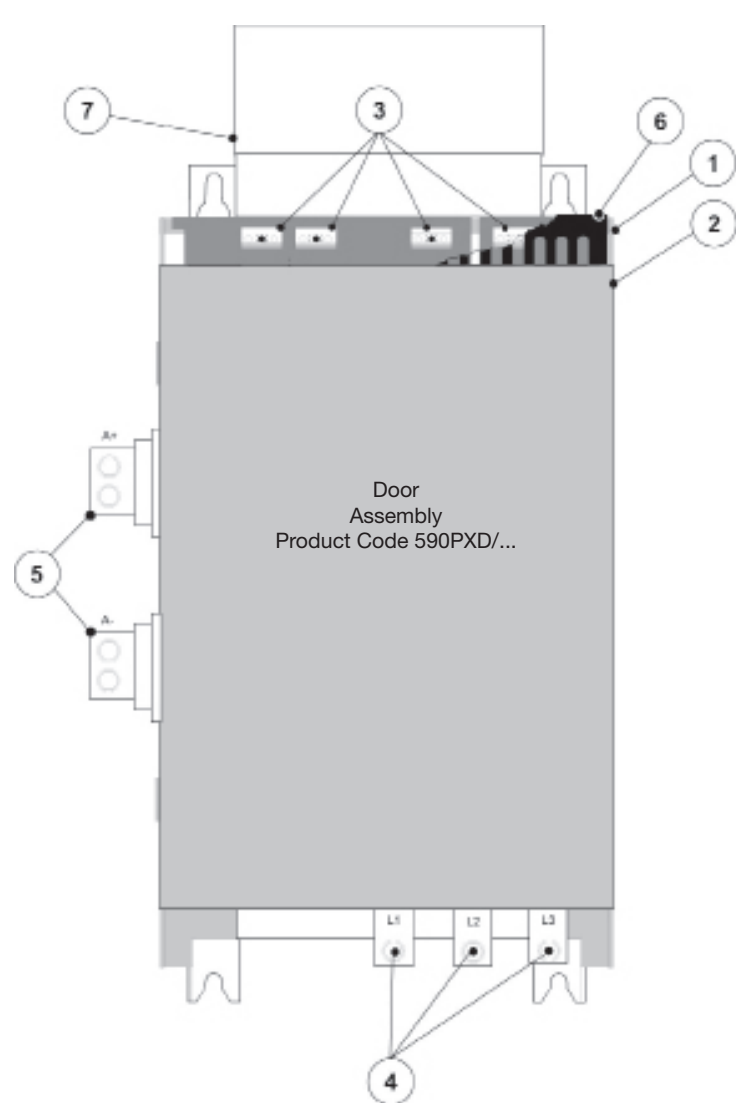

270 A Unit

Overview of Frame 4

1	Main drive assembly
2	Standard door assembly
3	Motor field terminals
4	Busbars - main power input
5	Busbars - main power output
6	Auxiliary supply, contactor and motor thermistor terminals
7	External vent (where fitted)
8	Contactor control select

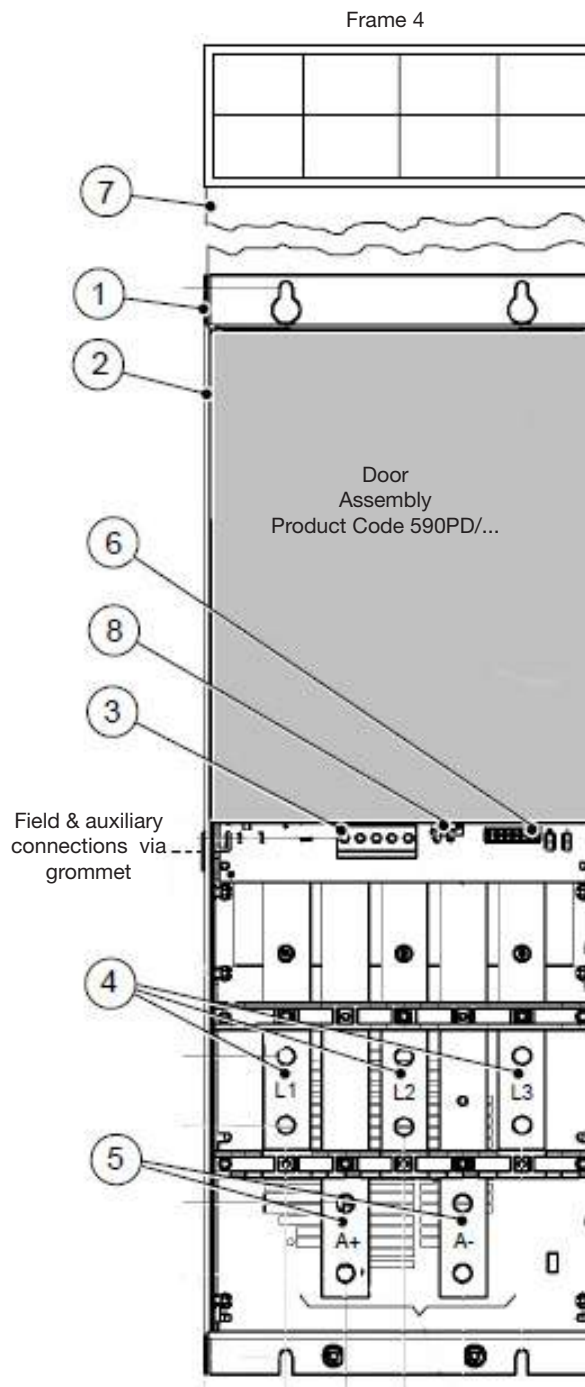

Overview of Frame 6

1	Phase assemblies - L1, L2, L3
2	Fishplate
3	Control panel assembly
4	Front cover
5	Standard door assembly
6	Field controller
7	Busbars - main power input
8	Busbars - main power output

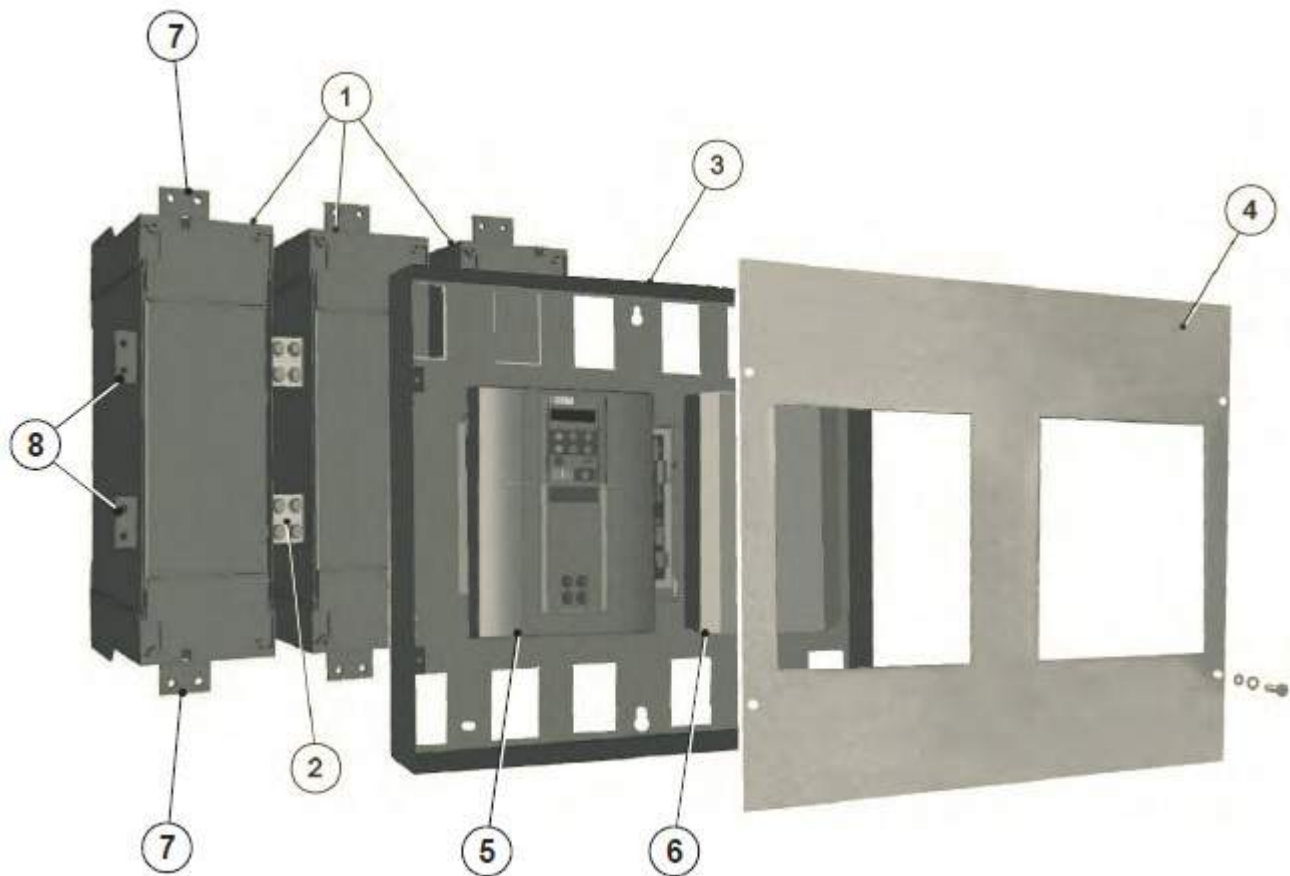

External Stack Controller - DC598+, DC599+ Series

The economical solution for retrofit applications

When upgrading machines equipped with older high power DC drives, the most cost-effective and quickest way is often to reuse the existing thyristor power stack, which in most cases will be in perfect working order. To preserve your investment, Parker SSD Drives has developed a DC598+ / DC599+ power stack controller offer specially aimed at retrofit applications and based on the DC590+ controller.

Available in 2 versions, the DC599+ two quadrant non-regenerative and DC598+ four quadrant full-regenerative versions, can be used to drive the power stacks of existing DC drives manufactured by Parker SSD or other manufacturers, delivering the benefits of the recent technological innovations of the DC590+ Series drive.

The DC598+ and DC599+ offer the ability to upgrade your equipment quickly and easily and integrates with your existing control equipment or SCADA package. The DC598+ and DC599+ retrofit solutions are recommended for currents above 800 A.

Benefits

- Reuse existing DC power stacks
- Connectivity over standard common fieldbuses (Including PROFIBUS, EtherNet, DeviceNet, CANopen)
- Easy to use operator interface
- Flexible common Integrator Series programming environment

The DC598/9+ provides the following:

- Thyristor firing signals
- Thyristor firing pulse transformers
- AC current transformer feedback rectification and scaling
- Armature voltage feedback interface
- Coding and phase rotation interface
- Mains present monitoring
- Heatsink over-temperature input
- Field power modules and input/output terminals
- Field current monitoring and scaling
- All standard DC590+ I/O terminals



Technical Characteristics

Supply Voltage	110...240 VAC ±10 % 220...500 VAC ±10 % 380...690 VAC ±10 % 3 ph coding or 1 ph power
Supply Frequency	50/60 Hz ±10 %
Output Field Current	60 ADC naturally cooled - 120 ADC force cooled (1 x Field Current DC value) Amps 1 ph. AC Nominal 3 ph AC
Field Output Voltage	(0.9 x 1 ph Supply Voltage) VDC
Total Losses	(3 x idc out) Watts.
Auxiliary Supply	110...240 VAC ±10 % 1 ph - Naturally cooled 110...120 VAC ±10 % 1 ph - Force cooled 115 V fan 220...240 VAC ±10 % 1ph - Force cooled 230 V fan
Auxiliary Supply Current	SMPS Quiescent Current = 500 mA 115 VAC or 250 mA 230 VAC ie 50 VA. Fan current - 270 mA @115 VAC or 135 mA @230 VAC
Auxiliary Supply Fuse	3 A
Operating Temp.	0...+45 °C
Storage Temp.	-25...+55 °C
Shipping Temp.	-25...+70 °C
Enclosure Rating	IP20
Altitude Rating	Maximum Altitude 500 m De-rate the output at 1 % per 200 m
Humidity	Maximum 85 % relative humidity at 45 % non-condensing
Atmosphere	Non flammable, non-corrosive and dust free
Climatic	Class 3k3 as defined by EN60721-3-3 (1995)

Accessories and Options

Overview

Options	Fitting	Order Reference
Operator Keypad		
DC590+ keypad (removable)	Option	6901-00-G
Advanced operator keypad (removeable)		6911-01-00-G
Keypad blank cover (use when keypad not fitted)		LA500326U001
Remote mounting kit		6052/00
Communication Cards		
EtherNet Modbus/TCP and EtherNet IP	Option	6055-ETH-00
LINKnet		6055-LNET-00
DeviceNet		6055-DNET-00
RS485 / Modbus		6055-EI00-00
PROFIBUS-DP		6055-PROF-00
CANopen DS402		6055-CAN-00
Speed Feedback Cards		
Wire-ended encoder Card	Option	AH387775U001
Analogue Tacho		AH500935U001
Drive Doors / Accessories		
Door for Frame 3	Standard	590PXD-0010-UK
Door for Frame 4		590PD-0010-UK
Frame 4 ventilation kit	Option	LA466717U001

Communication Cards

The communication cards allow the DC590+ to be connected to the most common industry standard fieldbuses.

Features

- Dimensions HxWxD:
127 mmx76.2 mmx25.4 mm
- LED indication of network and card status

EtherNet Communications Interface	
Order Code: 6055-ETH-00	
Supported Protocols	Modbus/TCP and EtherNet IP
Communication Speed	10/100 M bits/s
Station Address	Selectable via switch or Internet Explorer
Suitable for	DC590+ version 7.1+

PROFIBUS-DP Communications Interface	
Order Code: 6055-PROF-00	
Supported Protocols	PROFIBUS-DP
Communication Speed	Automatically detected
Station Address	Selectable via software
Suitable for	DC590+ version 5.x+

DeviceNet Communications Interface	
Order Code: 6055-DNET-00	
Supported Protocols	DeviceNet Drive Profile – Group 2 slave only
Station Address	DeviceNet Drive Profile – Group 2 slave only
Suitable for	DC590+ version 5.x+

RS485/Modbus Communications Interface	
Order Code: 6055-EI-00	
Supported Protocols	Modbus RTU, EI Bisynch ASCII
Cabling	RS485 2 or 4 wire
Communication Speed	300 to 115200 bits/s
Station Address	Selectable via software
Suitable for	DC590+ version 5.17+

CANopen Communications Interface	
Order Code: 6055-CAN-00	
Profile	DS402
Supported Messaged	SDO, PDO, NMT, SYNC
Communication Speed	20 k, 50 k, 125 k, 250 k, 500 k, 1 M bits/s selectable
Station Adress	Selectable via Switch
Suitable for	DC590+ version 5.x+

Feedback cards

Description

The encoder feedback card allows an incremental encoder to be fitted to the drive to provide accurate measurement of motor speed. The card also provides the encoder power supply.

Specifications

Maximum input frequency	100 kHz
Receiver current consumption	10 mA per channel
Input format	2 channel differential and quadrature
Differential input voltage	Minimum 3.5 V
Encoder output voltage	+5 V to 24 V adjustable (AH387775U001)
Power supply rating	2 W maximum
Power supply load	1.4 x output power
Terminal size	16 AWG maximum
Tightening torque	0.4 Nm

Order Codes

Order Code	Description
AH387775U001	Encoder Card - Adjustable supply

Operator Keypads

Standard operator keypad 6901-00-G

Features

- Local motor control: start, speed, direction, diagnostics
- Operator menus and parameter configuration
- Quick setup menu
- Password protection for parameter configuration

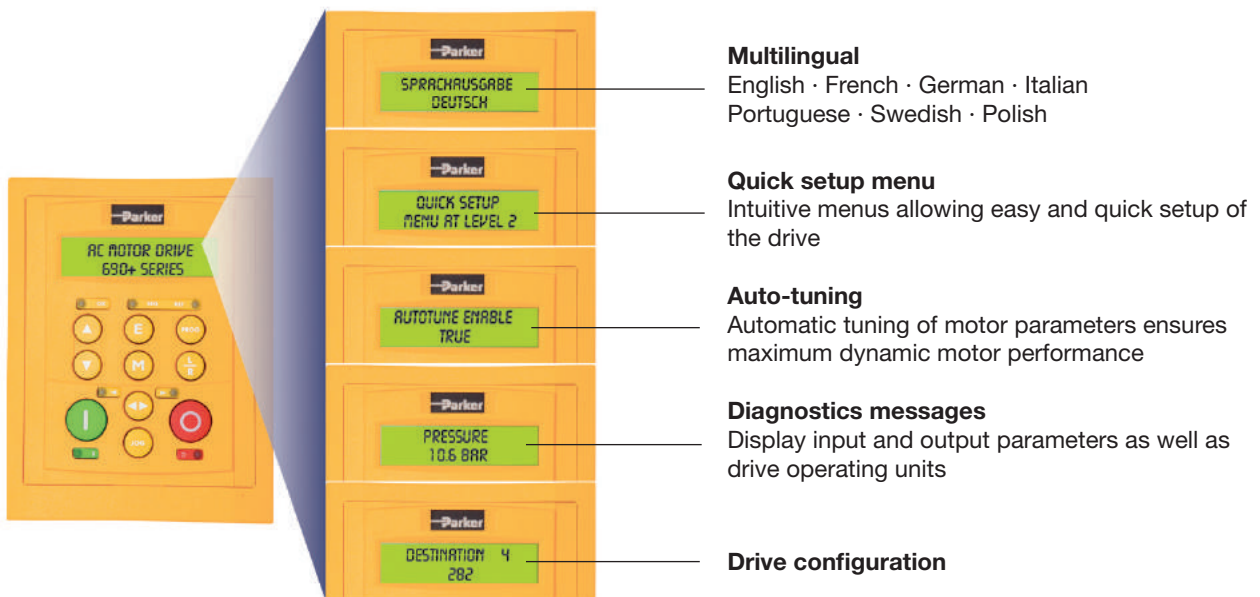

Drive System Explorer Lite (DSE Lite) Software

Description

DSE LITE software is an easy to use configuration, commissioning and monitoring tool with graphical interface for the Parker SSD Drives range of AC and DC drives. While the drive is in running mode the oscilloscope function allows "on-line" monitoring of selected parameters and the recording of trends.

DSE LITE, allows the user to create, parameterize and configure user defined applications thanks to function blocks dedicated to speed control, Winder, PID, Diameter calculator, Shaftless... DSE LITE is downloadable from our website. www.parker.com

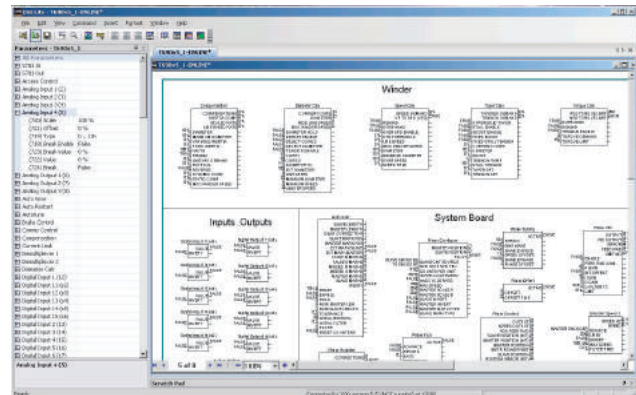
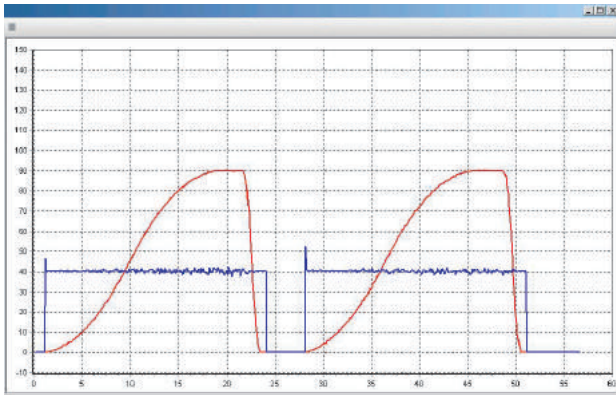

Order Codes

DC590+ Integrator Series, 110 V...500 V 3 phase

	1		2	3	4		5	6		7	8	9	10
Order example	590P	-	23	21501	0	-	P	00	-	U	4	V	0

1 Product Family

590P	DC590+ Series DC Digital Drive - 4 quadrant regenerative
591P	DC591+ Series DC Digital Drive - 2 quadrant non-regenerative

2 Supply Voltage

23	110...220 V 3 phase
53	220...500 V 3 phase

3 Current / Power Rating @110...220 VAC 3 ph

	Output current [A]	Frame
21501	15	1
23501	35	1
24002	40	2
27002	70	2
31102	110	2
31652	165	2
31803	180	3
32703	270	3
33804	380	4
35004	500	4
37254	725	4
38304	830	4

3 Current / Power Rating @220...500 VAC 3 ph

	Output current [A]	Frame
21501	15	1
23501	35	1
24002	40	2
27002	70	2
31102	110	2
31652	165	2
31803	180	3
32703	270	3
33804	380	4
35004	500	4
37254	725	4
38304	830	4
41256	1250	6
41606	1600	6
41956	1950	6

4 Auxiliary Supply

0	Universal 115 V...230 V 1 ph (Frames 1, 2, 6)
1	115 V 1 ph (Frames 3,4)
2	230 V 1 ph (Frames 3,4)

5 Mounting

P	Panel mounting (1)
----------	--------------------

6 Special Options

00	None
	Documented special options (refer to local sales office)

7 Languages

U	English (50/60 Hz) (2)
----------	------------------------

8 Keypad

4	6901 keypad fitted (3)
----------	------------------------

9 Speed Feedback

V	Armature voltage (4)
----------	----------------------

10 Communications

0	None (5)
----------	----------

(1) Frame 4 ventilation duct kit sold as separate part LA466717U001.

(2) Product sold with English as standard. Additional languages can be selected by the user on the 6901 keypad at product commissioning. German, French, Italian and Spanish.

(3) 6901 keypad included with standard product. This can be removed and replaced with blanking cover part number LA500326U001.

(4) Product supplied without feedback option fitted (armature voltage control). Encoder and tacho feedback options sold separately.

(5) Product supplied without communications options fitted. Options sold separately.

DC590+ Integrator Series 500 V...690 V 3 phase

	1		2	3	4		5	6		7	8	9	10
Order example	590P	-	63	33804	2	-	P	00	-	U	4	V	0

1 Product Family

590P	DC590+ Series DC Digital Drive - 4 quadrant regenerative
591P	DC591+ Series DC Digital Drive - 2 quadrant non-regenerative

2 Supply voltage

63	500...600 V 3 ph
73	500...690 V 3 ph

3 Current / Power Rating @500-600 V 3 ph

	Output current [A]	Frame
33804	380	4
35004	500	4
37254	725	4
38304	830	4

3 Current / Power Rating @500-690 V 3 ph

	Output current [A]	Frame
41256	1250	6
41606	1600	6
41956	1950	6

4 Auxiliary Supply

0	Universal 115 V...230 V 1ph (Frames 1, 2, 6)
1	115 V 1 ph (Frames 3...4)
2	230 V 1 ph (Frames 3...4)

5 Mounting

P	Panel mounting (1)
----------	--------------------

6 Special Options

00	None
	Documented special options (01...99) (refer to local sales office)

7 Languages

U	English (50/60 Hz) (2)
----------	------------------------

8 Keypad

4	6901 keypad fitted (3)
----------	------------------------

9 Speed Feedback

V	Armature voltage (4)
----------	----------------------

10 Communications

0	None (5)
----------	----------

(1) Frame 4 ventilation duct kit sold as separate part LA466717U001.

(2) Product sold with English as standard. Additional languages can be selected by the user on the 6901 keypad at product commissioning. German, French, Italian and Spanish.

(3) 6901 keypad included with standard product. This can be removed and replaced with blanking cover part number LA500326U001.

(4) Product supplied without feedback option fitted (armature voltage control). Encoder and tacho feedback options sold separately.

(5) Product supplied without communications options fitted. Options sold separately.

DC590PX+ Integrator Series

	1		2	3	4		5	6		7	8	9	10
Order example	590PX	-	23	23501	0	-	P	00	-	U	4	V	0

1 Product family

590PX	DC590PX Series DC Digital Drive - regenerative
591PX	DC591PX Series DC Digital Drive - non-regenerative

2 Supply voltage

23	110...220 V 3 ph
53	220...500 V 3 ph

3 Current / Power Ratings @110...220 V 3 ph

	Output current [A]	Frame Size
23501	35	1
27001	70	1
31101	110	1
31501	150	1

3 Current / Power Ratings @220...500 V 3 ph

	Output current [A]	Frame Size
23501	35	1
27001	70	1
31101	110	1
31501	150	1

4 Auxiliary Supply

0	Universal 115 V...230 V 1 ph (35/70 Amp ratings only)
1	115 V 1 ph (110/150 Amp ratings only)
2	230 V 1 ph (10/150 Amp ratings only)

5 Mounting

P	Panel mounting (1)
----------	--------------------

6 Special Options

00	None
	Documented special options (01...99) (refer to local sales office)

7 Languages

U	English (50/60 Hz) (2)
----------	------------------------

8 Keypad

4	6901 keypad installed (3)
----------	---------------------------

9 Speed Feedback

V	Armature voltage (4)
----------	----------------------

10 Communications

0	None (5)
----------	----------

(1) Frame 4 ventilation duct kit sold as separate part LA466717U001.

(2) Product sold with English as standard. Additional languages can be selected by the user on the 6901 keypad at product commissioning. German, French, Italian and Spanish.

(3) 6901 keypad included with standard product. This can be removed and replaced with blanking cover part number LA500326U001.

(4) Product supplied without feedback option fitted (armature voltage control). Encoder and tachometer feedback options sold separately.

(5) Product supplied without communications options fitted. Options sold separately.

DC590+ Series External Stack Controllers

	1		2	3	4		5	6	7		7	8	9	10
Order example	598P	-	23	26001	0	-	A	P	00	-	U	4	V	0

1 Product family

598P	DC598+ External Stack Controller - 2Q non-regenerative
599P	DC599+ External Stack Controller - 4Q Regenerative

2 Supply voltage

23	110...220 V 3 ph
53	220...500 V 3 ph
73	500...690 V 3 ph

3 Current / Power Ratings @110...220 V 3 ph

	Output current [A]	Frame Size
26001	60	1
31201	120	1

3 Current / Power Ratings @220...500 V 3 ph

	Output current [A]	Frame Size
26001	60	1
31201	120	1

3 Current / Power Ratings @500...690 V 3 ph

	Output current [A]	Frame Size
26001	60	1
31201	120	1

4 Auxiliary Supply

0	Universal 115 V...230 V 1 ph (60 Amp rating only)
1	115 V 1 ph (120 Amp rating only)
2	230 V 1 ph (120 Amp rating only)

5 Mounting

P Panel mounting (1)

6 Special Options

00 None
Documented special options (01...99)
(refer to local sales office)

7 Languages

U English (50/60 Hz) (2)

8 Keypad

4 6901 keypad installed (3)

9 Speed Feedback

V Armature voltage (4)

10 Communications

0 None (5)

(1) Frame 4 ventilation duct kit sold as separate part LA466717U001.

(2) Product sold with English as standard. Additional languages can be selected by the user on the 6901 keypad at product commissioning. German, French, Italian and Spanish.

(3) 6901 keypad included with standard product. This can be removed and replaced with blanking cover part number LA500326U001.

(4) Product supplied without feedback option fitted (armature voltage control). Encoder and tachometer feedback options sold separately.

(5) Product supplied without communications options fitted. Options sold separately.



Parker's Motion & Control Technologies

At Parker, we're guided by a relentless drive to help our customers become more productive and achieve higher levels of profitability by engineering the best systems for their requirements. It means looking at customer applications from many angles to find new ways to create value. Whatever the motion and control technology need, Parker has the experience, breadth of product and global reach to consistently deliver. No company knows more about motion and control technology than Parker. For further info call 00800 27 27 5374



Aerospace Key Markets

Aftermarket services
Commercial transports
Engines
General & business aviation
Helicopters
Launch vehicles
Military aircraft
Missiles
Power generation
Regional transports
Unmanned aerial vehicles

Key Products

Control systems & actuation products
Engine systems & components
Fluid conveyance systems & components
Fluid metering, delivery & atomization devices
Fuel systems & components
Fuel tank inerting systems
Hydraulic systems & components
Thermal management
Wheels & brakes



Climate Control Key Markets

Agriculture
Air conditioning
Construction Machinery
Food & beverage
Industrial machinery
Life sciences
Oil & gas
Precision cooling
Process
Refrigeration
Transportation

Key Products

Accumulators
Advanced actuators
CO₂ controls
Electronic controllers
Filter driers
Hand shut-off valves
Heat exchangers
Hose & fittings
Pressure regulating valves
Refrigerant distributors
Safety relief valves
Smart pumps
Solenoid valves
Thermostatic expansion valves



Electromechanical Key Markets

Aerospace
Factory automation
Life science & medical
Machine tools
Packaging machinery
Paper machinery
Plastics machinery & converting
Primary metals
Semiconductor & electronics
Textile
Wire & cable

Key Products

AC/DC drives & systems
Electric actuators, gantry robots & slides
Electrohydraulic actuation systems
Electromechanical actuation systems
Human machine interface
Linear motors
Stepper motors, servo motors, drives & controls
Structural extrusions



Filtration Key Markets

Aerospace
Food & beverage
Industrial plant & equipment
Life sciences
Marine
Mobile equipment
Oil & gas
Power generation & renewable energy
Process
Transportation
Water Purification

Key Products

Analytical gas generators
Compressed air filters & dryers
Engine air, coolant, fuel & oil filtration systems
Fluid condition monitoring systems
Hydraulic & lubrication filters
Hydrogen, nitrogen & zero air generators
Instrumentation filters
Membrane & fiber filters
Microfiltration
Sterile air filtration
Water desalination & purification filters & systems



Fluid & Gas Handling Key Markets

Aerial lift
Agriculture
Bulk chemical handling
Construction machinery
Food & beverage
Fuel & gas delivery
Industrial machinery
Life sciences
Marine
Mining
Mobile
Oil & gas
Renewable energy
Transportation

Key Products

Check valves
Connectors for low pressure fluid conveyance
Deep sea umbilicals
Diagnostic equipment
Hose couplings
Industrial hose
Mooring systems & power cables
PTFE hose & tubing
Quick couplings
Rubber & thermoplastic hose
Tube fittings & adapters
Tubing & plastic fittings



Hydraulics Key Markets

Aerial lift
Agriculture
Alternative energy
Construction machinery
Forestry
Industrial machinery
Machine tools
Marine
Material handling
Mining
Oil & gas
Power generation
Refuse vehicles
Renewable energy
Truck hydraulics
Turf equipment

Key Products

Accumulators
Cartridge valves
Electrohydraulic actuators
Human machine interfaces
Hybrid drives
Hydraulic cylinders
Hydraulic motors & pumps
Hydraulic systems
Hydraulic valves & controls
Hydrostatic steering
Integrated hydraulic circuits
Power take-offs
Power units
Rotary actuators
Sensors



Pneumatics Key Markets

Aerospace
Conveyor & material handling
Factory automation
Life science & medical
Machine tools
Packaging machinery
Transportation & automotive

Key Products

Air preparation
Brass fittings & valves
Manifolds
Pneumatic accessories
Pneumatic actuators & grippers
Pneumatic valves & controls
Quick disconnects
Rotary actuators
Rubber & thermoplastic hose & couplings
Structural extrusions
Thermoplastic tubing & fittings
Vacuum generators, cups & sensors



Process Control Key Markets

Alternative fuels
Biopharmaceuticals
Chemical & refining
Food & beverage
Marine & shipbuilding
Medical & dental
Microelectronics
Nuclear Power
Offshore oil exploration
Oil & gas
Pharmaceuticals
Power generation
Pulp & paper
Steel
Water/wastewater

Key Products

Analytical instruments
Analytical sample conditioning products & systems
Chemical injection fittings & valves
Fluoropolymer chemical delivery fittings, valves & pumps
High purity gas delivery fittings, valves, regulators & digital flow controllers
Industrial mass flow meters/ controllers
Permanent no-weld tube fittings
Precision industrial regulators & flow controllers
Process control double block & bleeds
Process control fittings, valves, regulators & manifold valves



Sealing & Shielding Key Markets

Aerospace
Chemical processing
Consumer
Fluid power
General industrial
Information technology
Life sciences
Microelectronics
Military
Oil & gas
Power generation
Renewable energy
Telecommunications
Transportation

Key Products

Dynamic seals
Elastomeric o-rings
Electro-medical instrument design & assembly
EMI shielding
Extruded & precision-cut, fabricated elastomeric seals
High temperature metal seals
Homogeneous & inserted elastomeric shapes
Medical device fabrication & assembly
Metal & plastic retained composite seals
Shielded optical windows
Silicone tubing & extrusions
Thermal management
Vibration dampening

Parker Worldwide

Europe, Middle East, Africa

AE – United Arab Emirates, Dubai
Tel: +971 4 8127100
parker.me@parker.com

AT – Austria, Wiener Neustadt
Tel: +43 (0)2622 23501-0
parker.austria@parker.com

AT – Eastern Europe, Wiener Neustadt
Tel: +43 (0)2622 23501 900
parker.easteurope@parker.com

AZ – Azerbaijan, Baku
Tel: +994 50 2233 458
parker.azerbaijan@parker.com

BE/LU – Belgium, Nivelles
Tel: +32 (0)67 280 900
parker.belgium@parker.com

BG – Bulgaria, Sofia
Tel: +359 2 980 1344
parker.bulgaria@parker.com

BY – Belarus, Minsk
Tel: +375 17 209 9399
parker.belarus@parker.com

CH – Switzerland, Etoy
Tel: +41 (0)21 821 87 00
parker.switzerland@parker.com

CZ – Czech Republic, Klecany
Tel: +420 284 083 111
parker.czechrepublic@parker.com

DE – Germany, Kaarst
Tel: +49 (0)2131 4016 0
parker.germany@parker.com

DK – Denmark, Ballerup
Tel: +45 43 56 04 00
parker.denmark@parker.com

ES – Spain, Madrid
Tel: +34 902 330 001
parker.spain@parker.com

FI – Finland, Vantaa
Tel: +358 (0)20 753 2500
parker.finland@parker.com

FR – France, Contamine s/Arve
Tel: +33 (0)4 50 25 80 25
parker.france@parker.com

GR – Greece, Athens
Tel: +30 210 933 6450
parker.greece@parker.com

HU – Hungary, Budaörs
Tel: +36 23 885 470
parker.hungary@parker.com

IE – Ireland, Dublin
Tel: +353 (0)1 466 6370
parker.ireland@parker.com

IT – Italy, Corsico (MI)
Tel: +39 02 45 19 21
parker.italy@parker.com

KZ – Kazakhstan, Almaty
Tel: +7 7273 561 000
parker.easteurope@parker.com

NL – The Netherlands, Oldenzaal
Tel: +31 (0)541 585 000
parker.nl@parker.com

NO – Norway, Asker
Tel: +47 66 75 34 00
parker.norway@parker.com

PL – Poland, Warsaw
Tel: +48 (0)22 573 24 00
parker.poland@parker.com

PT – Portugal, Leca da Palmeira
Tel: +351 22 999 7360
parker.portugal@parker.com

RO – Romania, Bucharest
Tel: +40 21 252 1382
parker.romania@parker.com

RU – Russia, Moscow
Tel: +7 495 645-2156
parker.russia@parker.com

SE – Sweden, Spånga
Tel: +46 (0)8 59 79 50 00
parker.sweden@parker.com

SK – Slovakia, Banská Bystrica
Tel: +421 484 162 252
parker.slovakia@parker.com

SL – Slovenia, Novo Mesto
Tel: +386 7 337 6650
parker.slovenia@parker.com

TR – Turkey, Istanbul
Tel: +90 216 4997081
parker.turkey@parker.com

UA – Ukraine, Kiev
Tel: +380 44 494 2731
parker.ukraine@parker.com

UK – United Kingdom, Warwick
Tel: +44 (0)1926 317 878
parker.uk@parker.com

ZA – South Africa, Kempton Park
Tel: +27 (0)11 961 0700
parker.southafrica@parker.com

North America

CA – Canada, Milton, Ontario
Tel: +1 905 693 3000

US – USA, Cleveland
Tel: +1 216 896 3000

Asia Pacific

AU – Australia, Castle Hill
Tel: +61 (0)2-9634 7777

CN – China, Shanghai
Tel: +86 21 2899 5000

HK – Hong Kong
Tel: +852 2428 8008

IN – India, Mumbai
Tel: +91 22 6513 7081-85

JP – Japan, Tokyo
Tel: +81 (0)3 6408 3901

KR – South Korea, Seoul
Tel: +82 2 559 0400

MY – Malaysia, Shah Alam
Tel: +60 3 7849 0800

NZ – New Zealand, Mt Wellington
Tel: +64 9 574 1744

SG – Singapore
Tel: +65 6887 6300

TH – Thailand, Bangkok
Tel: +662 186 7000-99

TW – Taiwan, Taipei
Tel: +886 2 2298 8987

South America

AR – Argentina, Buenos Aires
Tel: +54 3327 44 4129

BR – Brazil, Sao Jose dos Campos
Tel: +55 800 727 5374

CL – Chile, Santiago
Tel: +56 2 623 1216

MX – Mexico, Toluca
Tel: +52 72 2275 4200



EMEA Product Information Centre

Free phone: 00 800 27 27 5374

(from AT, BE, CH, CZ, DE, DK, EE, ES, FI, FR, IE, IL, IS, IT, LU, MT, NL, NO, PL, PT, RU, SE, SK, UK, ZA)

US Product Information Centre

Toll-free number: 1-800-27 27 537

www.parker.com